

Architekten:
Johnston Marklee

veröffentlicht in Heft 01/2016

HÄUSER

Sharon Johnston und Mark Lee
1545 Pontius Ave
Los Angeles, CA 90025, USA
Tel.: +1-310-442 4886
www.johnstonmarklee.com

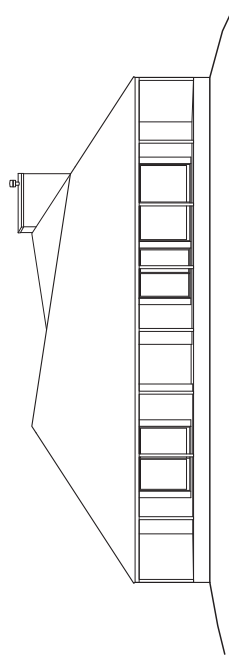
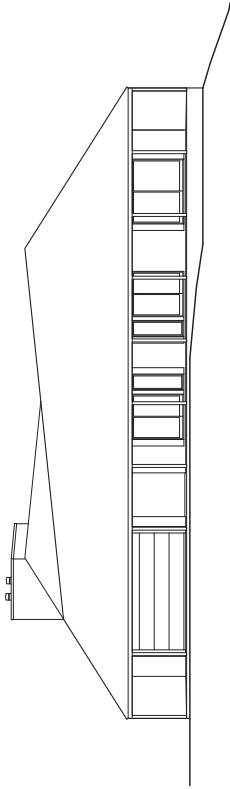

1
10 11

1
0

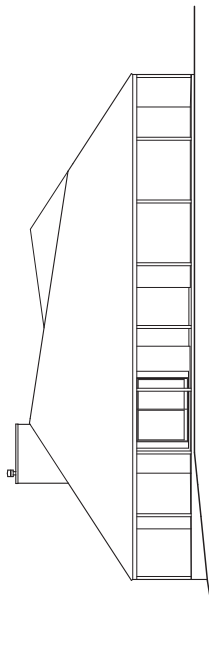
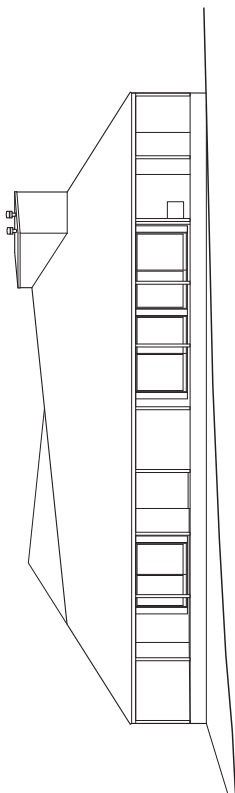

KAUAI II
EIGHTH PLAN - 1/16" = 1'-0"

Sharon Johnston und Mark Lee
1545 Pontius Ave
Los Angeles, CA 90025, USA
Tel.: +1-310-442 4886
www.johnstonmarklee.com

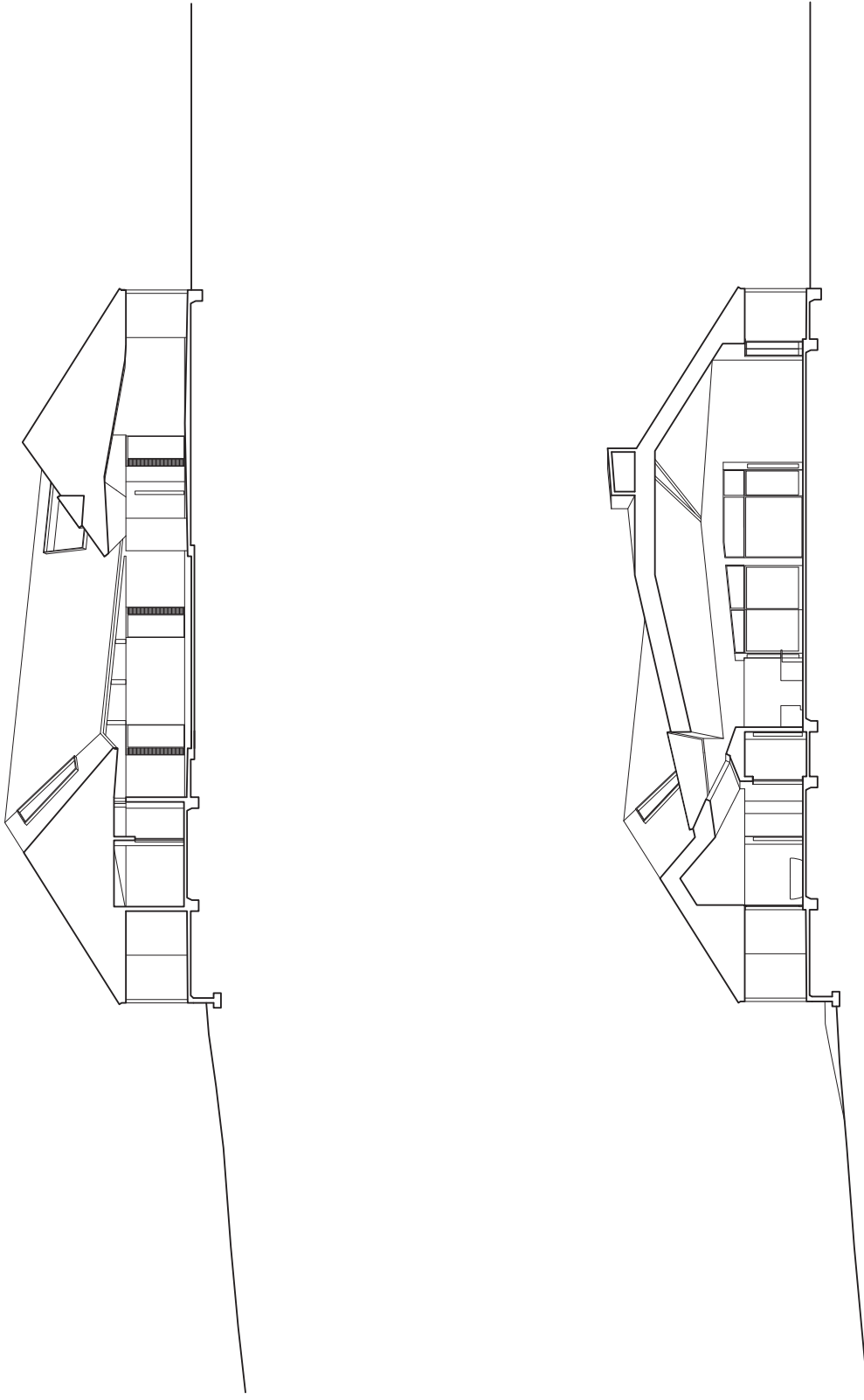

1
0
10 ft

HUT HOUSE
LONGITUDINAL SECTION - 1/16" = 1'-0"

Sharon Johnston und Mark Lee
1545 Pontius Ave
Los Angeles, CA 90025, USA
Tel.: +1-310-442 4886
www.johnstonmarklee.com

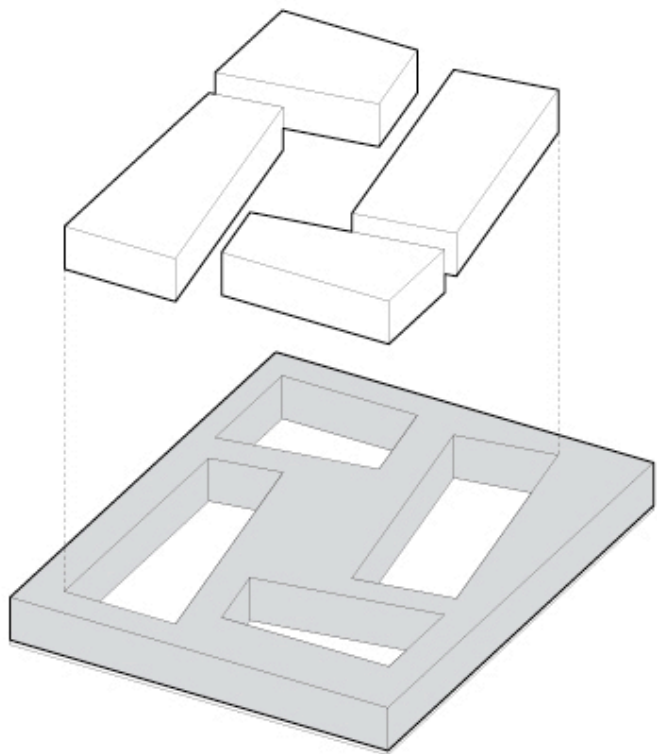

Interior and Exterior Volumes

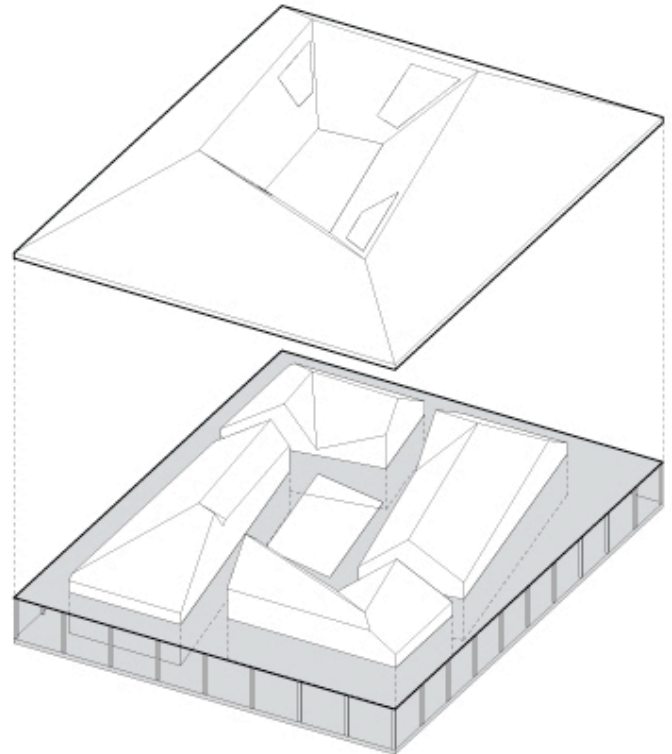

Flat Lanai

Sharon Johnston und Mark Lee
1545 Pontius Ave
Los Angeles, CA 90025, USA
Tel.: +1-310-442 4886
www.johnstonmarklee.com

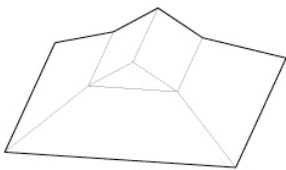

Traditional Hawaiian roof

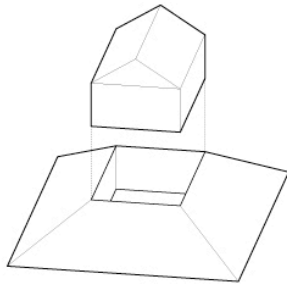

Courtyard

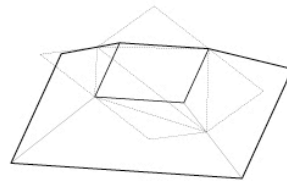

Folded cutting plane

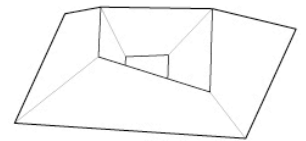

Roof geometry

Sharon Johnston und Mark Lee
1545 Pontius Ave
Los Angeles, CA 90025, USA
Tel.: +1-310-442 4886
www.johnstonmarklee.com

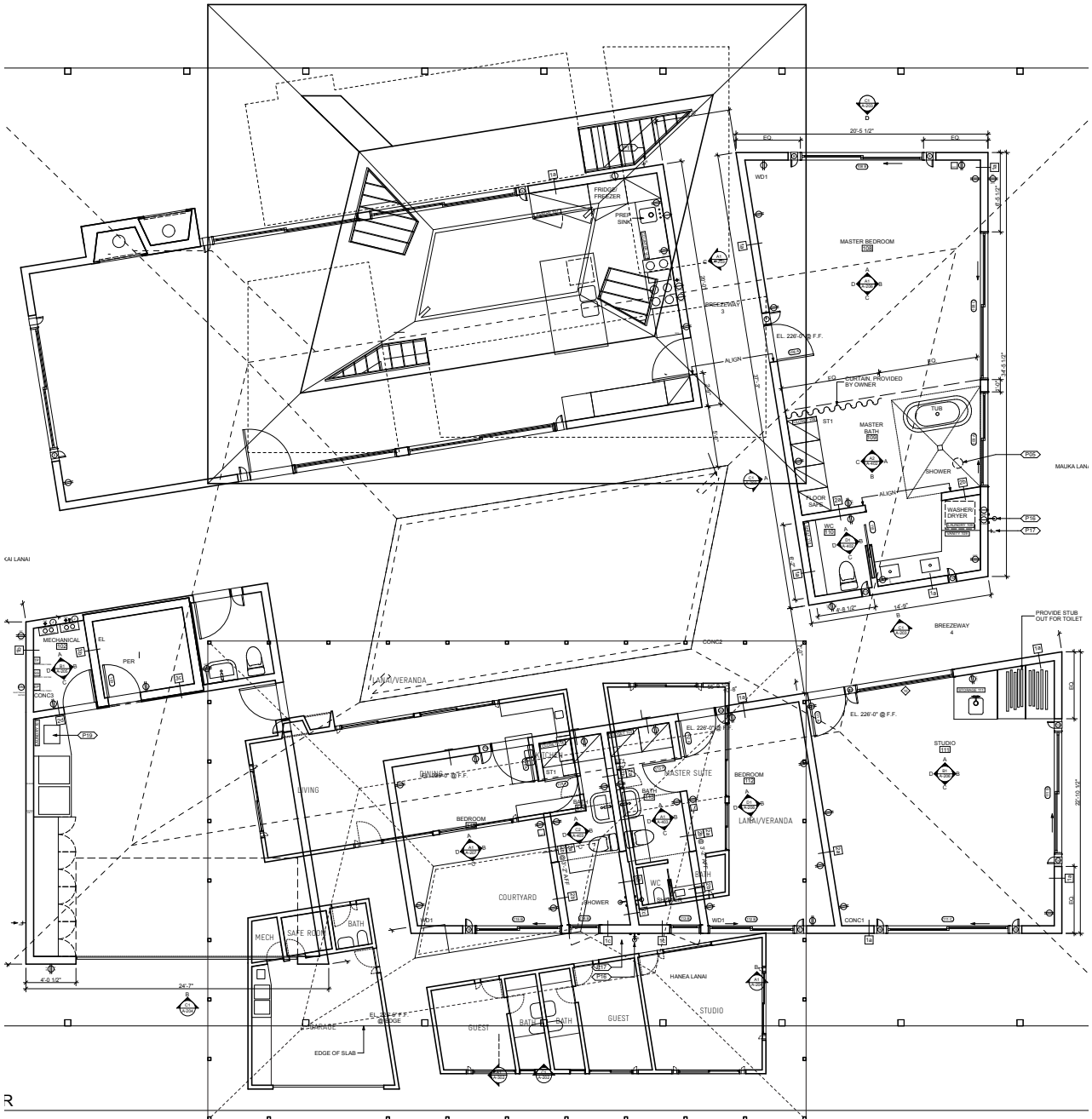

KAUAI II
FLOOR PLAN - 1/16" = 1'-0"

1 1 1
N 0 10 R